



Pure Energy Equipment

GARMO RDGA-L4

plug-in 3M1-I-R290-DVO-I4



PLUG-IN → MULTIDECKS

Garmo RDGA-L4

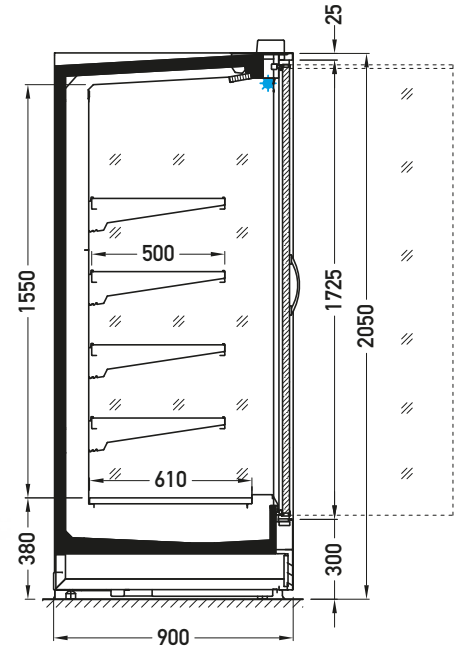

M1 TEMPERATURE CLASS

modules **1250 1875 2500**



Standard features:

- **plug-in unit**
- High-Vision doors
- eco-friendly R290 refrigerant
- inverter compressor
- top lighting
- very low noise level (<49 dB per 2.5 mod.)
- very low heat emission (**0,98 kW per 2.5 mod.**)
- very low energy consumption (6,7 kWh/24h per 2.5 mod.)*
- additional accessories in standard version (i.e. price holder)
- 4 rows of hanging shelves with adjustable height and inclination (0°, 10°, 20°) + base shelf
- price holders on suspended and base shelves (39 mm)
- transport locks for shelves
- hot gas defrosting
- low front

Standard external colours

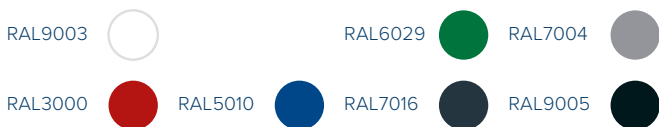

Standard screenprinting colours

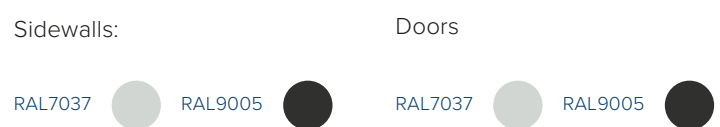

* stores conditions: +20°C/50% RH



PLUG-IN → MULTIDECKS

Garmo RDGA-L4



Calculations:

RDGA-L4-2500

SIDE-BY-SIDE COMPARISON

MODEL	1	2
	Typical cooling multidecks	RDGA-L4-2500 3M1 - I-R290 - DVO-I4
ENERGY CONSUMPTION TEC [kWh/24h]	21,7	6,67
TOTAL DISPLAY AREA TDA [m ²]	3,52	5,13
ENERGY EFFICIENCY INDEX - EEI	41,7	9,4
BETTER EEI [%]		77%

DVO - double doors open (self closing)

Climate class No. 3
EN ISO 23953-2:2015

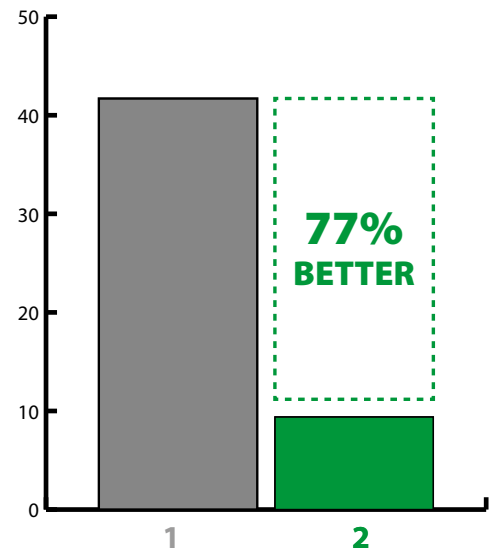
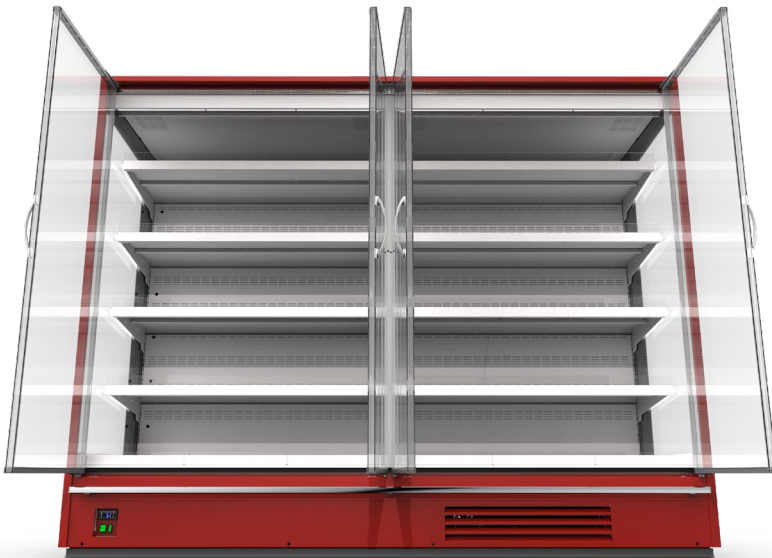



PLUG-IN → MULTIDECKS

Garmo RDGA-L4



Options:



– flow system compatible

FLOWsystem is a water loop solution developed by JBG-2 that allows you to easily manage the heat generated by refrigeration equipment.

The system effectively transfers heat from the sales area to the selected location and allows you to manage it further.

FLOWsystem is an easy, economic and ecologic way to achieve immediate savings in your retail store operational costs, regardless of whether it operates independently or is integrated with other installations.

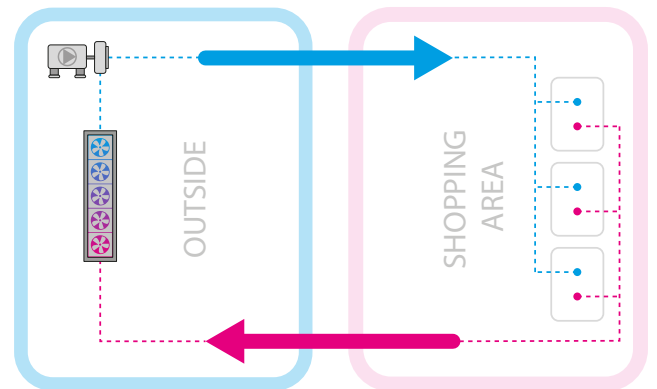

Lighting options:

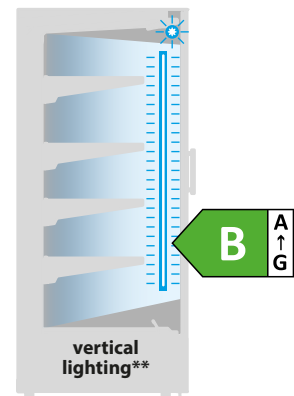
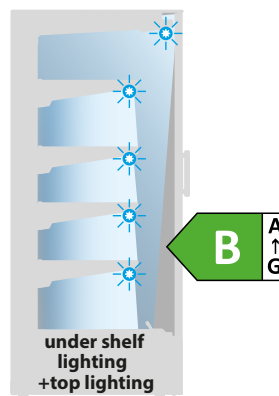
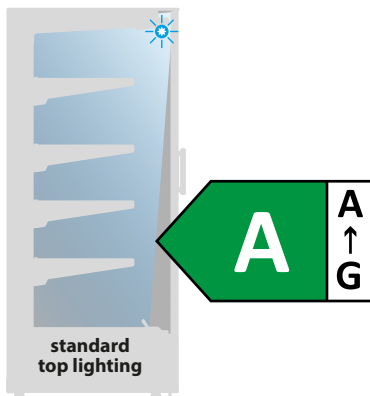

**requires power supply on a separate circuit,



LEDit tube

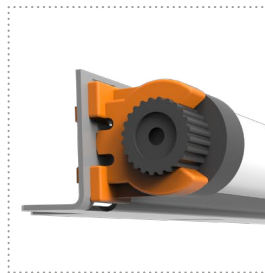
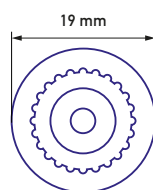

LEDit tube is mounted in rotary holders (patented pending), which ensures the correct positioning of the luminous flux.

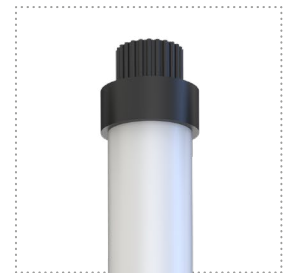

LEDit matt tubes



PLUG-IN → MULTIDECKS

Garmo RDGA-L4



Door options:

DVO

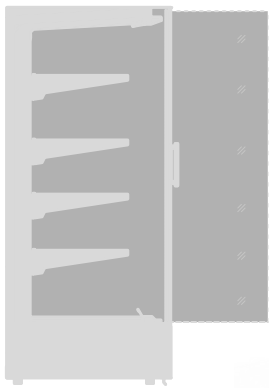

High Vision

Highly transparent elements significantly improve the visibility and multiply the spectacular effect. Precise fitting eliminates the requirement for rubber profiles and allows maintaining good parameters of equipment performance at the same time.



Bumper options:



Stainless tube - \varnothing 25 mm
clutched (plastic handle)
(T1B)



Stainless tube - 2 x \varnothing 25 mm
(T2B)



Stainless rectangular
profile (T4A)



Stainless square 25x25
(T9B)



PLUG-IN → MULTIDECKS

Garmo RDGA-L4



Sidewall options:



display sidewall



full square sidewall



full square sidewall with mirror



Connection sidewall option:



connecting modules requires intermediate sidewall



High mobile divider:

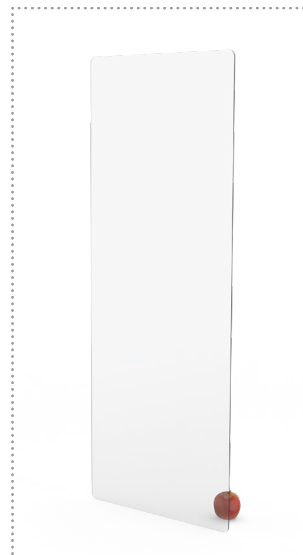

low mobile divider available in various heights



PLUG-IN → MULTIDECKS

Garmo RDGA-L4



Exposition options:

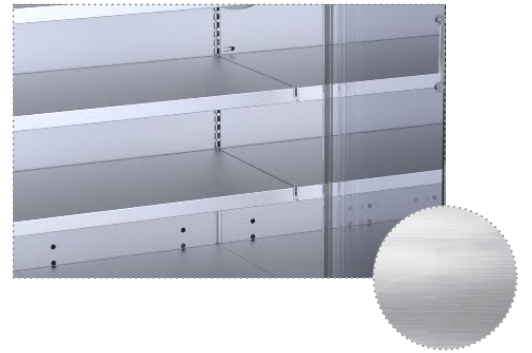

Stainless steel display surface (X5CrNi18-10)



Evaporator coating options:

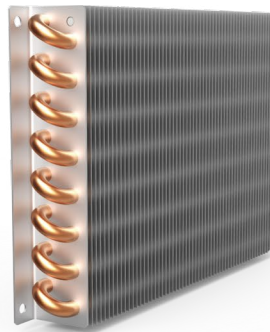

Standard



Electrophoretic coating



Top mirror option:

Additional mirror available
The mirror is attached directly to the casing

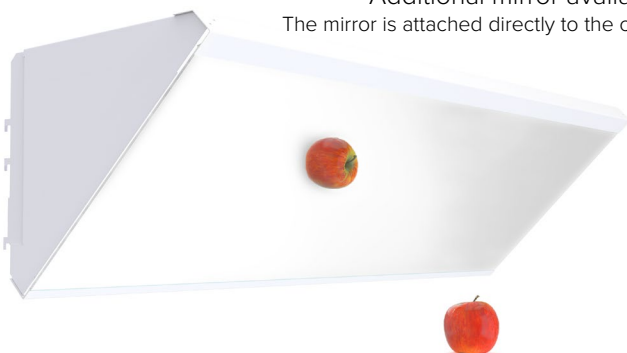



PLUG-IN → MULTIDECKS

Garmo RDGA-L4



Price holder options:

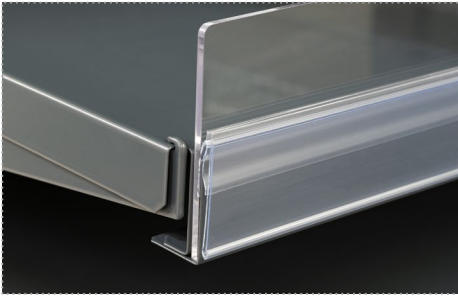

WLK price holder bracket
with shelf lighting - option

height - 39 mm standard, (52 mm option)

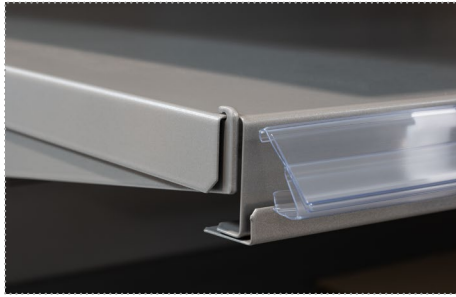

LSR price holder - option

height - 39 mm standard, (30 mm, 52 mm option)

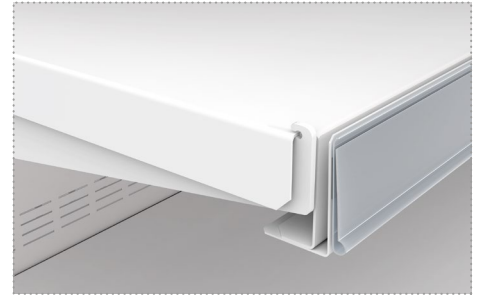

DBR price holder - standard

height - 39 mm standard, (52 mm, 60 mm option)

available colors



white



black



transp



white



black



transp



RAL 7016



RAL 8022



RAL 9006



white



transp



black



Perspex shelf riser options:



Perspex shelf riser height - 85 / 120 mm



Standard adjustable shelves:



hanging shelves with adjustable
height and inclination (0°, 10°, 20°)

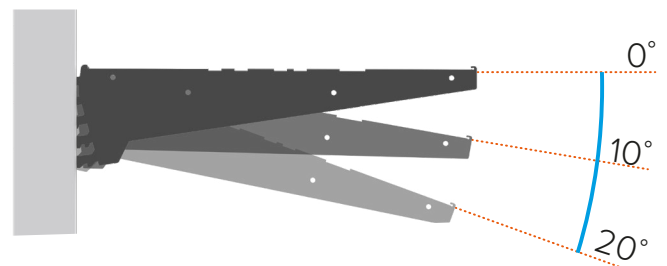



PLUG-IN → MULTIDECKS

Garmo RDGA-L4



Wire accessories options:



Bottom wire basket 620mm x 600mm x 220mm



Bottom wire grid 620mm x 450mm



Standard transport lock:

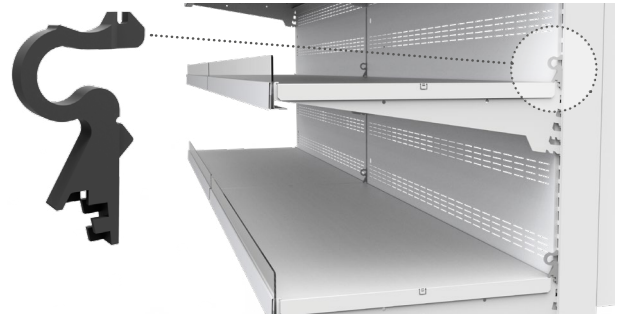

Shelf support transport lock in multidecks.



COOL EQUIPMENT WARM RELATIONS

JBG-2 Sp. z o.o.
ul. Gajowa 5
43-254 Warszowice

Office:
E : info@jbg2.com
T : +48 32 494 00 00

v1.0 09.2022

Photos, visualization or designs presented in the brochure
are not a commercial offer of JBG-2

